

PROJECT NAME
CYGNUS

BASED ON
Cornish G-2

BUILD DIFFICULTY
■■■■□ Intermediate

EFFECT TYPE
Distortion / Sustainer, Fuzz

DOCUMENT VERSION
1.0.0 (2019-03-14)

PROJECT SUMMARY

Based on the classic Big Muff circuit, this pedal adds a meticulously-tuned buffered bypass along with an additional transistor-based buffer stage on the effect input.

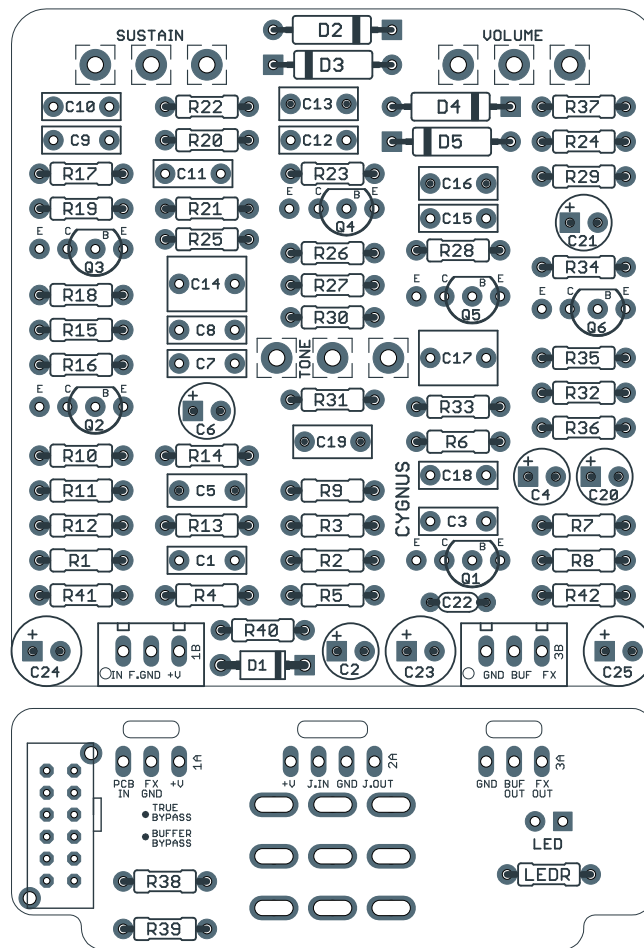

Actual size is 2.3" x 2.43" (main board) and 2.3" x 0.87" (bypass board).

TABLE OF CONTENTS

1	Project Overview	8	Drill Template
2	Introduction & Usage	9	Enclosure Layout
3-5	Parts List	10	Wiring Diagram
6	Build Notes	11	Licensing
7	Schematic	11	Document Revisions

INTRODUCTION

The Cygnus Distortion/Sustainer is adapted from the Pete Cornish G-2, a Big Muff-based circuit.

Cornish pedals are probably best known for being extremely expensive. There are two reasons for this. First, the build quality and reliability is unmatched. Second, the mysterious nature of them, partially due to the fact that the circuit is obscured and partially because of the A-list of clients. (The G-2 is most famously used by David Gilmour.)

Inside, the circuit is a basic Big Muff with a few changes such as the use of germanium diodes for clipping instead of silicon, and of course the famous class-A transistor buffer design. Both buffers together (the bypass buffer and effect input buffer) have almost as many parts as the main circuit!

The Cygnus is a faithful reproduction of the G-2 circuit, but with one major update: an internal switch allowing the pedal to be used in true-bypass mode instead of buffered bypass. As with the Klon KTR, the buffer mode is “almost always better”, but you can be the judge of that.

USAGE

The Cygnus has the following controls:

- **Sustain** controls the amount of drive or distortion, which also affects the amount of sustain.
- **Tone** is a basic high-cut filter.
- **Volume** is the overall output.

PARTS LIST

This parts list is also available in a spreadsheet format which can be imported directly into Mouser for easy parts ordering. Mouser doesn't carry all the parts (most notably potentiometers) so the second tab lists all the non-Mouser parts as well as sources for each.

[View parts list spreadsheet](#) →

PART	VALUE	TYPE	NOTES
R1	10M	Metal film resistor, 1/4W	
R2	1k	Metal film resistor, 1/4W	
R3	120k	Metal film resistor, 1/4W	
R4	120k	Metal film resistor, 1/4W	
R5	200k	Metal film resistor, 1/4W	
R6	7k5	Metal film resistor, 1/4W	
R7	20k	Metal film resistor, 1/4W	
R8	51R	Metal film resistor, 1/4W	
R9	1M	Metal film resistor, 1/4W	
R10	1k	Metal film resistor, 1/4W	
R11	120k	Metal film resistor, 1/4W	
R12	68k	Metal film resistor, 1/4W	
R13	150k	Metal film resistor, 1/4W	
R14	8k2	Metal film resistor, 1/4W	
R15	39k	Metal film resistor, 1/4W	
R16	100k	Metal film resistor, 1/4W	
R17	470k	Metal film resistor, 1/4W	
R18	15k	Metal film resistor, 1/4W	
R19	680R	Metal film resistor, 1/4W	
R20	1k	Metal film resistor, 1/4W	
R21	8k2	Metal film resistor, 1/4W	
R22	100k	Metal film resistor, 1/4W	
R23	470k	Metal film resistor, 1/4W	
R24	15k	Metal film resistor, 1/4W	
R25	680R	Metal film resistor, 1/4W	
R26	8k2	Metal film resistor, 1/4W	
R27	100k	Metal film resistor, 1/4W	
R28	470k	Metal film resistor, 1/4W	
R29	15k	Metal film resistor, 1/4W	
R30	100R	Metal film resistor, 1/4W	

PARTS LIST, CONT.

PART	VALUE	TYPE	NOTES
R31	100k	Metal film resistor, 1/4W	
R32	390k	Metal film resistor, 1/4W	
R33	100k	Metal film resistor, 1/4W	
R34	8k2	Metal film resistor, 1/4W	
R35	2k2	Metal film resistor, 1/4W	
R36	620R	Metal film resistor, 1/4W	
R37	39k	Metal film resistor, 1/4W	
R38	91R	Metal film resistor, 1/4W	
R39	49.9k	Metal film resistor, 1/4W	Original is 50k. This is the closest available value. Can also use 51k.
R40	100R	Metal film resistor, 1/4W	
R41	120R	Metal film resistor, 1/4W	
R42	100R	Metal film resistor, 1/4W	
LEDR	4k7	Metal film resistor, 1/4W	LED current-limiting resistor. Adjust value to change LED brightness.
C1	100n	Film capacitor, 7.2 x 2.5mm	
C2	4.7uF	Electrolytic capacitor, 4mm	
C3	1n	Film capacitor, 7.2 x 2.5mm	
C4	22uF	Electrolytic capacitor, 5mm	
C5	220n	Film capacitor, 7.2 x 2.5mm	
C6	4.7uF	Electrolytic capacitor, 4mm	
C7	10n	Film capacitor, 7.2 x 2.5mm	
C8	47n	Film capacitor, 7.2 x 2.5mm	
C9	1n	Film capacitor, 7.2 x 2.5mm	
C10	47n	Film capacitor, 7.2 x 2.5mm	
C11	47n	Film capacitor, 7.2 x 2.5mm	
C12	1n	Film capacitor, 7.2 x 2.5mm	
C13	220n	Film capacitor, 7.2 x 2.5mm	
C14	2.2uF	Film capacitor, 7.2 x 5mm	
C15	1n	Film capacitor, 7.2 x 2.5mm	
C16	220n	Film capacitor, 7.2 x 2.5mm	
C17	2.2uF	Film capacitor, 7.2 x 5mm	
C18	10n	Film capacitor, 7.2 x 2.5mm	
C19	220n	Film capacitor, 7.2 x 2.5mm	
C20	22uF	Electrolytic capacitor, 5mm	
C21	22uF	Electrolytic capacitor, 5mm	
C22	100n	MLCC capacitor, X7R	Power supply filter capacitor.

PARTS LIST, CONT.

PART	VALUE	TYPE	NOTES
C23	220uF	Electrolytic capacitor, 6.3mm	Power supply filter capacitor.
C24	100uF	Electrolytic capacitor, 6.3mm	Power supply filter capacitor.
C25	220uF	Electrolytic capacitor, 6.3mm	Power supply filter capacitor.
D1	1N5817	Schottky diode, DO-41	
D2	1N34A	Germanium diode	Exact part number is unimportant. Any germanium should work here.
D3	1N34A	Germanium diode	Exact part number is unimportant. Any germanium should work here.
D4	1N34A	Germanium diode	Exact part number is unimportant. Any germanium should work here.
D5	1N34A	Germanium diode	Exact part number is unimportant. Any germanium should work here.
Q1	2N5088	BJT transistor, NPN, TO-92	The original uses BC549C, but 2N5088 is the U.S. equivalent.
Q2	2N5088	BJT transistor, NPN, TO-92	The original uses BC549C, but 2N5088 is the U.S. equivalent.
Q3	2N5088	BJT transistor, NPN, TO-92	The original uses BC549C, but 2N5088 is the U.S. equivalent.
Q4	2N5088	BJT transistor, NPN, TO-92	The original uses BC549C, but 2N5088 is the U.S. equivalent.
Q5	2N5088	BJT transistor, NPN, TO-92	The original uses BC549C, but 2N5088 is the U.S. equivalent.
Q6	2N5088	BJT transistor, NPN, TO-92	The original uses BC549C, but 2N5088 is the U.S. equivalent.
SUST.	50kA	16mm right-angle PCB mount pot	
TONE	25kA	16mm right-angle PCB mount pot	
VOL.	10kA	16mm right-angle PCB mount pot	
TB-BUF	4PDT slide	Slide switch, 4PDT	E-Switch EG4208 (4mm lever) or EG4208A (6mm lever)
IN	1/4" mono	1/4" phone jack, closed frame	Switchcraft 111X or equivalent.
OUT	1/4" mono	1/4" phone jack, closed frame	Switchcraft 111X or equivalent.
DC	2.1mm	DC jack, 2.1mm panel mount	Mouser 163-4302-E or equivalent.
FSW	3PDT	Stomp switch, 3PDT	
ENC	125B	Enclosure, die-cast aluminum	Can also use a Hammond 1590N1.

BUILD NOTES

Transistor selection

The original G-2 uses BC549C transistors. The pinout on the Cygnus PCB is for the U.S. “E-B-C” convention as used by the 2N3904 and 2N5088. The 2N5088 should operate identically to the BC549C, but if you do want to use the original transistors, just note that the pinout is different. Typically they would need to be rotated 180 degrees, but check the datasheet for your brand as they do vary.

Bypassing the true bypass / buffer switch

The E-Switch EG4208 slide switch used for the true bypass/buffer selector is available from Mouser Electronics but may not be accessible to everyone. If you are unable to obtain it, you can hard-wire the switch to either true bypass mode or buffered mode by soldering jumpers to the switch pads.

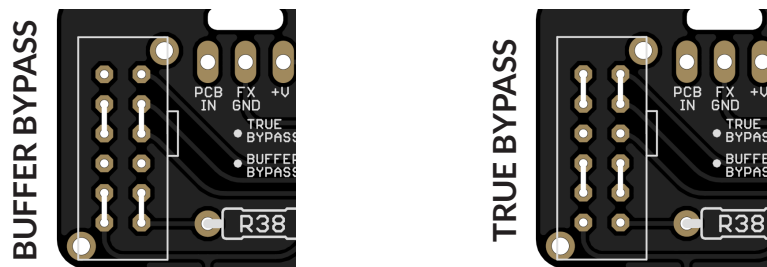

Tone modifications

Cornish pedals are legendary for their reliability and the quality of their buffered bypass systems. However, the G-2 in particular is known for having significantly more low-end than a standard Big Muff circuit and this can sometimes be too much in a live setting depending on the mix.

Fortunately, you can get all of the benefits of the buffered bypass while also making the rest of the circuit a little less bass-heavy and more similar to vintage Big Muffs. Here is a set of suggested mods:

- **C1:** 100n → 27n
- **C5:** 220n → 47n
- **C9:** 1n → 470pF (MLCC)
- **C12:** 1n → 470pF (MLCC)
- **C13:** 220n → 100n
- **C15:** 1n → 470pF (MLCC)
- **C16:** 220n → 100n
- **C19:** 220n → 100n

You can also compare the main part of the circuit (C8 onward in the schematic) with your favorite Muff variant to tailor it even more to your liking. The tone control is the only part of the circuit that departs from the classic Big Muff topology.

SCHEMATIC

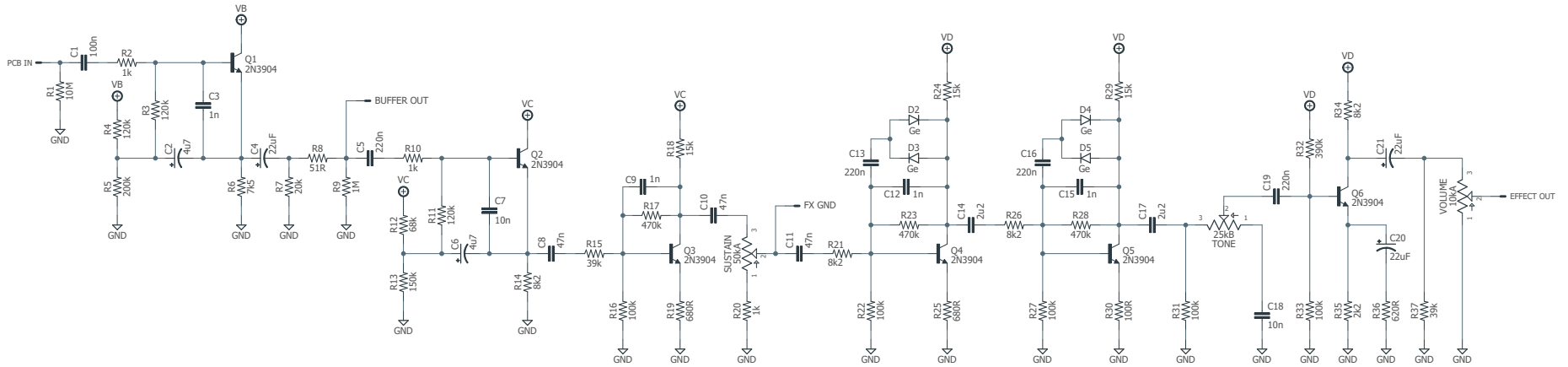
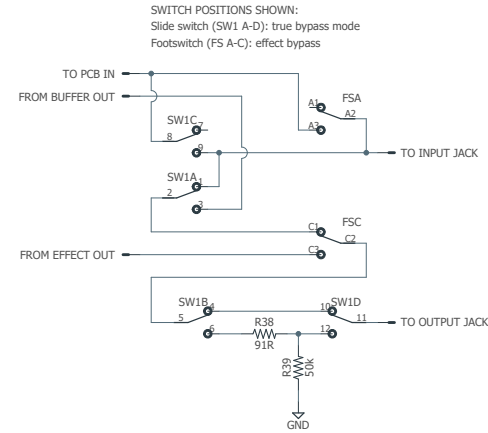
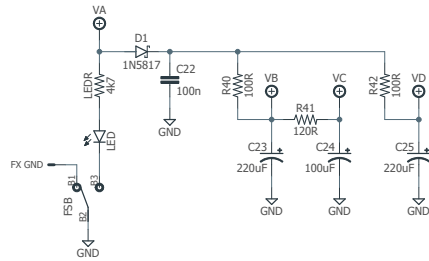

DRILL TEMPLATE

Cut out this drill template, fold the edges and tape it to the enclosure. Before drilling, it's recommended to first use a center punch for each of the holes to help guide the drill bit.

Ensure that this template is printed at 100% or "Actual Size". You can double-check this by measuring the scale on the printed page.

Top jack layout assumes the use of closed-frame jacks like the [Switchcraft 111X](#). If you'd rather use open-frame jacks, please refer to the Open-Frame Jack Drill Template for the top side.

LED hole drill size assumes the use of a [5mm LED bezel](#), available from several parts suppliers. Adjust size accordingly if using something different, such as a 3mm bezel, a plastic bezel, or just a plain LED.

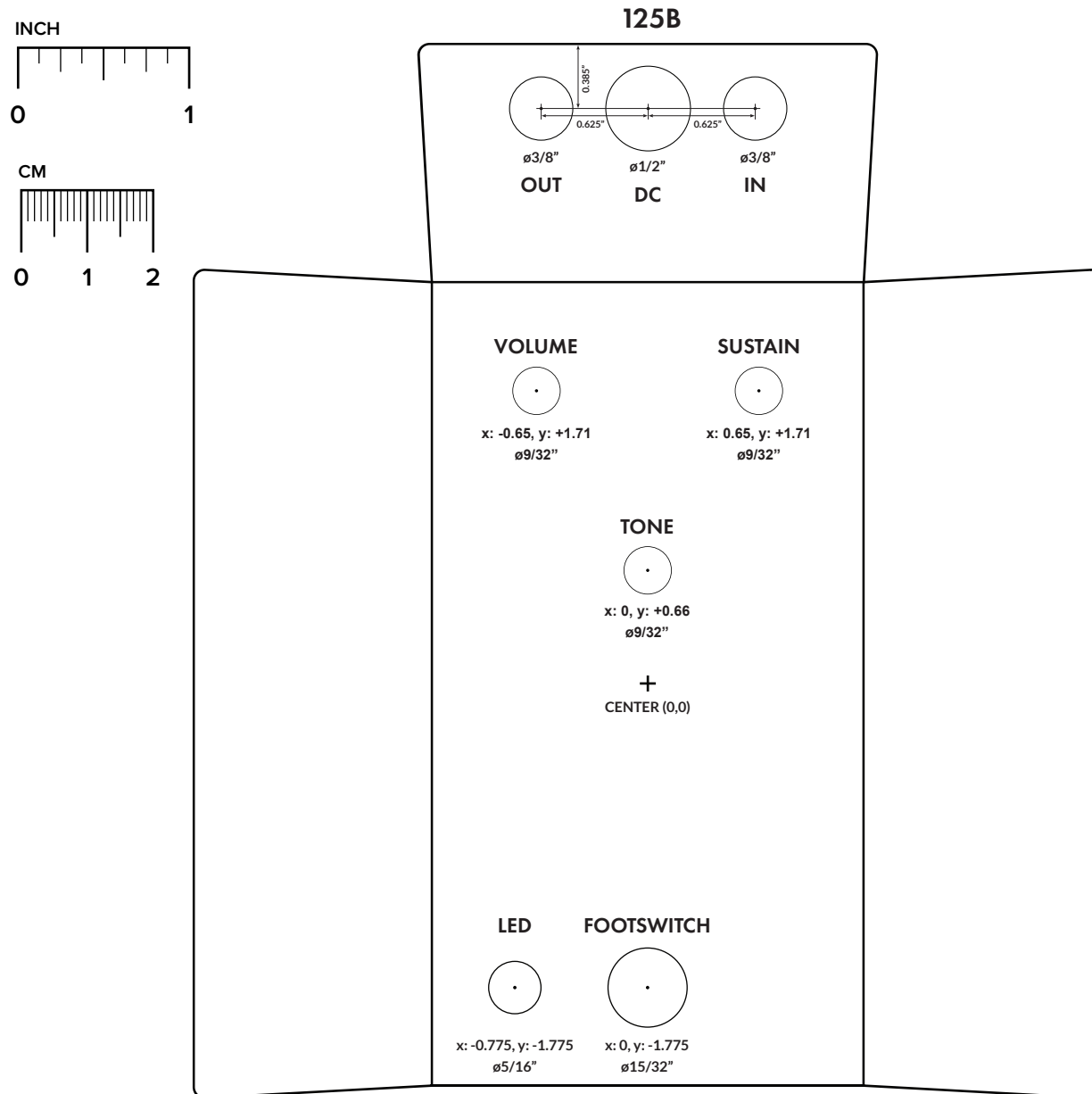

Note: On version 1 of the Cygnus, the LED is slightly misaligned from the drill template. You'll have to bend it back so it fits the drill hole. It will be fixed in the next revision of the PCB.

ENCLOSURE LAYOUT

Enclosure is shown without jacks. See next page for jack layout and wiring.

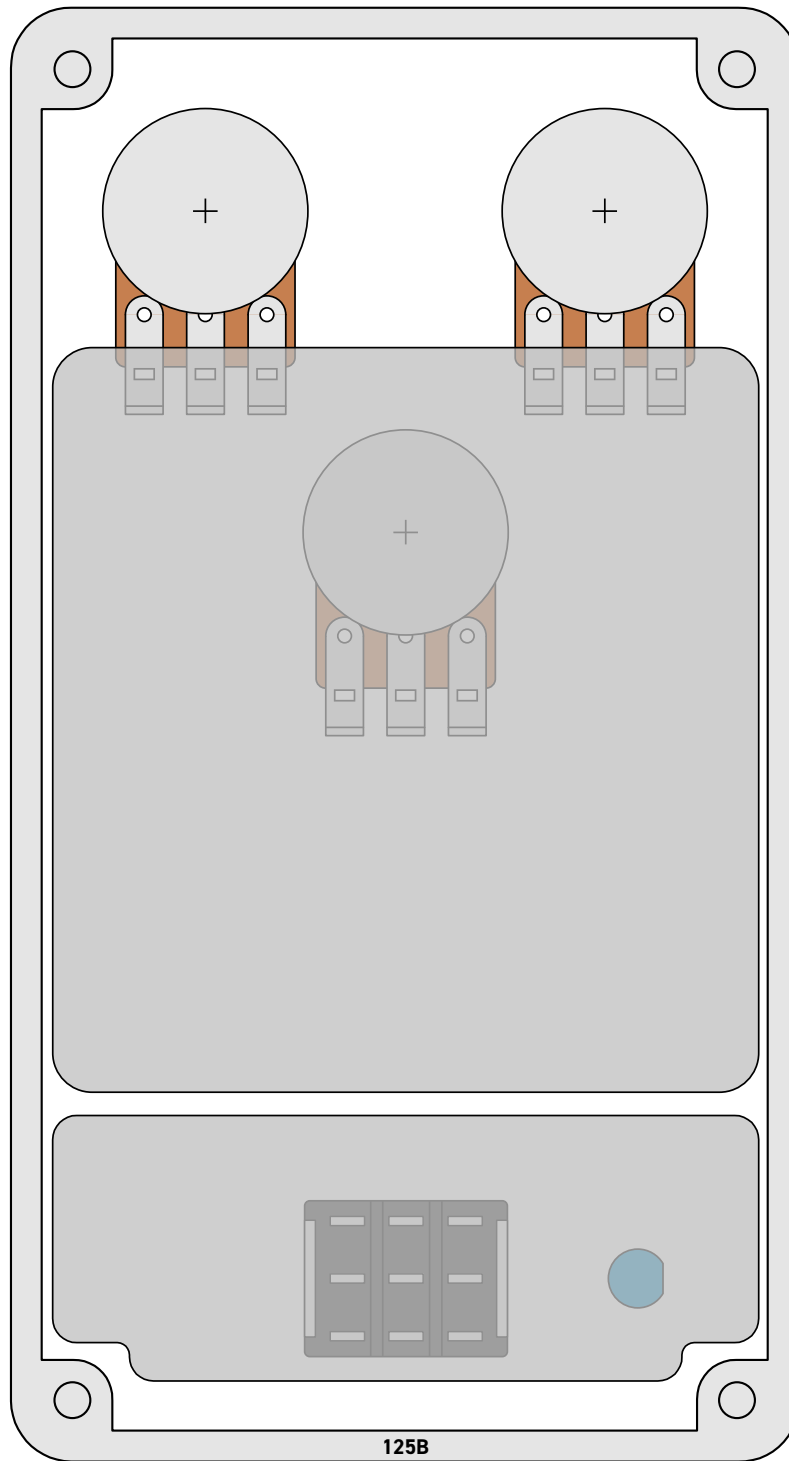

WIRING DIAGRAM

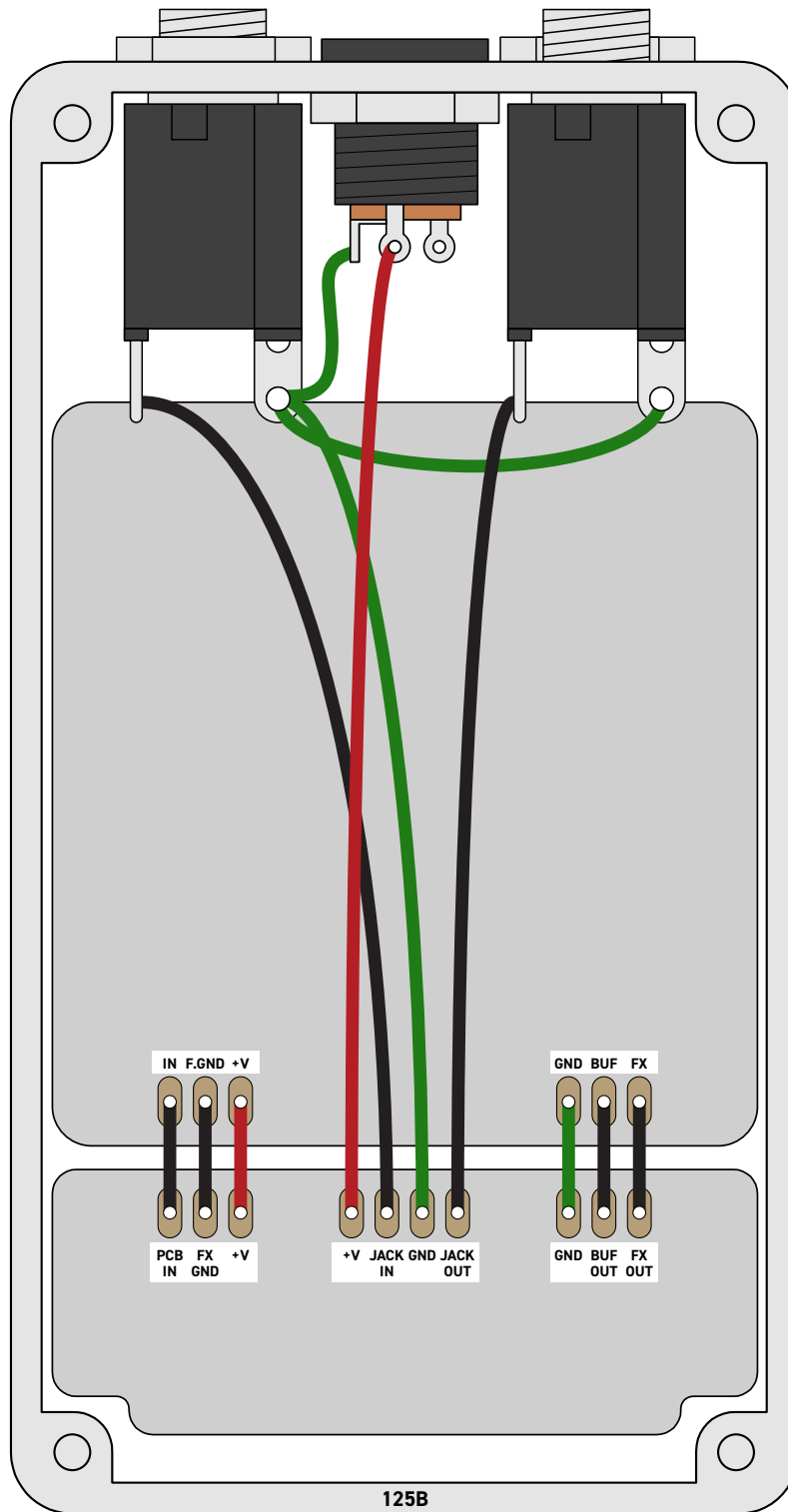

LICENSE & USAGE

No direct support is offered for these projects beyond the provided documentation. It's assumed that you have at least some experience building pedals before starting one of these. Replacements and refunds cannot be offered unless it can be shown that the circuit or documentation are in error.

All of these circuits have been tested in good faith in their base configurations. However, not all the modifications or variations have necessarily been tested. These are offered only as suggestions based on the experience and opinions of others.

Projects may be used for commercial endeavors in any quantity unless specifically noted. No attribution is necessary, though a link back is always greatly appreciated. The only usage restrictions are that **(1) you cannot resell the PCB as part of a kit without prior arrangement, and (2) you cannot "goop" the circuit, scratch off the screenprint, or otherwise obfuscate the circuit to disguise its source.** (In other words: you don't have to go out of your way to advertise the fact that you use these PCBs, but please don't go out of your way to hide it. The guitar effects industry needs more transparency, not less!)

DOCUMENT REVISIONS

1.0.0 (2019-03-14)

Initial release.